

**Zorro II/III DMA
USB2.0 controller
for AMIGA**



Legal notes

- Information in this manual has been assembled and checked with all possible accuracy. Anyhow, we cannot be made responsible for errors or missing parts.
- We cannot be made responsible for damages which are caused by using any information given in this manual.
- Technical specification of hardware and / or software may be changed by E3B and Chris Hodges without further notification.
- This manual may not be copied or reproduced in any way and by any means, including optical and electronical proceedings without prior written permission of E3B. This also applies to translations into other languages.
- E3B and Chris Hodges cannot be made responsible for damages due to erroneous or lost data caused by malfunction or wrong application of the **DENE3** and / or the software included in this package.
- Damages caused by misaligned plugging and static discharges at the expansion module and / or the computer it was installed are explicitly not covered by guarantee.

Trademarks

- **DENE3** is a trademark of E3B.
- Names and products used in this manual may be registered trademarks or products of the corresponding company, even if they are used in this manual without further notice.

Contact

- Hardware: Michael Böhmer, Fa. E3B | Hohlleitenweg 11d | 85410 Haag | mboehmer@e3b.de
- Software: Chris Hodges | Motorstraße 34a | 80809 München | chrisly@platon42.de



Inhaltsverzeichnis

1. Unpacking	3
2. Specifications	3
3. Basic information on the USB	4
3.1. General hints	4
3.2. Power consumption	5
3.3. Connectors	5
4. Zorro II/III, PIO and DMA - things you should know	6
5. Jumper- and LED description	7
6. Hardware installation	9
6.1. Safety recommendations	9
6.2. Needed materials	9
6.3. Installation in Amiga 2000	9
6.4. Installation in Amiga 3000 / 4000	10
6.5. Installation in Amiga 3000T / 4000T	10
6.6. Installation in Amiga 1200 Tower	10
6.7. Installing the hub ports	11
7. Setup and first steps	11
7.1. The first start	11
7.2. Software installation	11
7.3. Trouble shooting	12
8. Setting up Poseidon	12
A. Firmware upgrade	13



Thanks for choosing our **DENE3** card !

By acquiring the **DENE3** you have chosen a high quality product. Years of experience from our previous moduls SUBWAY, HIGHWAY and ALGOR (PRO) have been put into the development of **DENE3**.

As a result we can offer you a product which simple is the best USB solution in terms of user friendliness and performance for the Amiga Classic.

This package contains Poseidon - a very powerful USB stack, winner of the Amiga Award 2002. It has established as de-facto standard for USB on Amiga and is included as full featured OEM license. The version V4.0 is exclusively licensed to E3B customers.

This documentation is intended to guide you through the installation process for hard- and software components of the **DENE3**. Moreover it contains basic information on the operation of USB devices.

Please read this documentation carefully **BEFORE** trying to install software and hardware on your own. You will avoid problems - and in a worst case scenario - hardware damage to your Amiga an / or your new **DENE3** board.

Most recent information as well as software updates can be found on our website: <http://www.e3b.de/usb/>

Disposal of your old product



We take responsibility for our products also after they reach their end of life. Your **DENE3** has been manufactured with high quality components after the RoHS guideline.

Please inform yourself about the local separate collection system for electrical and electronical products. Please act according to your local rules.



1. Unpacking

Your **DENE3** package should contain the following items:

- one **DENE3** card (Zorro II/III version)
- one holding plate with two USB adapter cables
- this manual

Please check your **DENE3** package after unpacking for missing parts! Missing parts should be immediately reported to your dealer. The Poseidon USB stack is included in the FlashROM of your **DENE3**.

2. Specifications of **DENE3**

- USB2.0 controller for Amiga Zorro II / III bus systems
- fast 32bit card design for highest performance on Zorro III
- compatible with Buster Rev. 9 and 11
- real Zorro III DMA possible (system depending)
- PIO operation possible on both Zorro II and Zorro III
- 4MB FlashROM for including USB stack and other system software
- complete autoconfiguration according to Zorro II / III
- integrated USB2.0 root hub with three ports
- compatible with USB 1.1 and 2.0 devices (**full** support of 480MBit/s high speed mode)
- all USB ports are protected against overcurrent and short circuit
- modern power saving 1.8V / 2.5V / 3.3V technology
- bus logic update possible by software
- data rates of up to 8MB/s (DMA), up to 6MB/s (PIO)
- seamless integration of USB into AmigaOS by Poseidon
- optional clockport compatible expansion port
- installation software included in FlashROM
- high quality four layer PCB with hard plated gold connectors



3. Basic information on USB

The USB (Universal Serial Bus) has established meanwhile as standard for attaching peripheral devices to PCs. In its current revision 2.0 it allows rates of 1.5Mbit/s (low speed), 12 Mbit/s (full speed) and 480Mbit/s (high speed). Many USB devices are standardized and available in a huge number of variants for decent prices.

Your **DENE3** cards allows you to expand your Amiga by modern peripheral devices in the most easy way. By supporting the highspeed mode the **DENE3** is the ideal choice for connecting mass storage devices and network adaptors.

The well known software package Poseidon by Chris Hodges is included as full featured OEM license. You can use USB on your Amiga without additional costs right out of the box!

Poseidon supports many standardized USB devices like memory sticks, card readers, input devices (mice, keyboards, tablets), PATA and SATA adapters for harddisks, network adapters, sound cards, hubs, USB printers and exotic devices like USB rocket launchers.

3.1. General hints

Your **DENE3** has been designed for internal Zorro busses as found in Amiga 2000, 3000, 4000 and 1200 tower housings. Please check your computer manual before installation on information on how to add an expansion card.

Be careful: the **DENE3** may be not be inserted into Zorro slots the wrong way!

Damages caused by incorrectly fitted boards on the **DENE3** and / or your Amiga are not covered by guarantee.



3.2. Power consumption

One **DENE3** with three devices connected to her ports can consume up to 1.5 Ampere of current. Especially fully equipped Amigas (harddisks, turbo cards) can get unstable in this condition.

Please check carefully if your power supply is able to deliver the power needed by external devices before connecting USB devices to your **DENE3**.

Especially modern turbo- and graphic cards and fast harddisk may use almost all power resources delivered by Commodore or Amiga original power supplies.

Connecting additional bus powered USB devices to your **DENE3** can get you over the 2 Ampere power limit of the Zorro specification!

Possible solutions:

- If possible, use your USB devices "self powered" with their own power supplies attached.
- Connect an USB hub with own power supply..

In case of insufficient power supply you can expect not reproducible malfunctions and instable operation. Especially USB harddisks are known to be affected by these symptoms.

3.3. DENE3 connectors

The **DENE3** has three connector blocks: the hub ports (10 pin header), one internal USB connector and a clockport compatible connector (22pin header).

Please have a look at figure 1: all connector positions and PCB markings can be found there for reference issues.

During installation two cables have to be connected to the **DENE3** board. Figure 1 also illustrates the correct orientation of the cables. Please use this reference if you are in doubt during installation.

DENE3

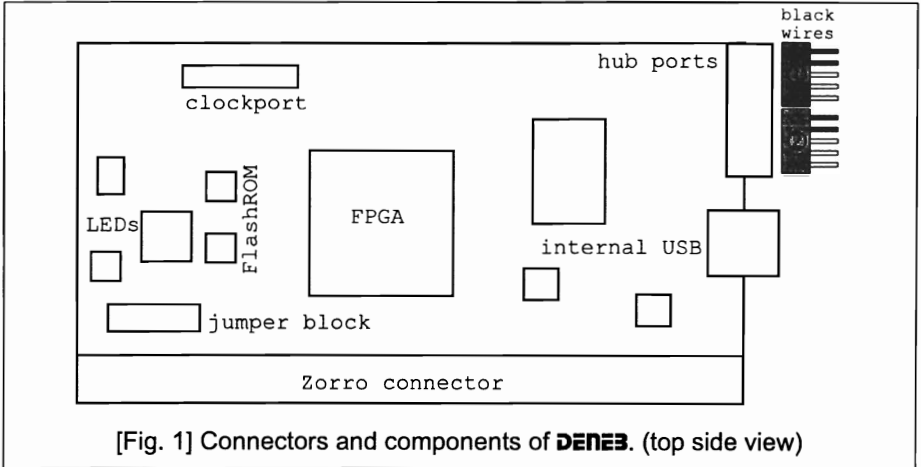

[Fig. 1] Connectors and components of **DENE3**. (top side view)

4. Zorro II/III, PIO and DMA- things you should know

The **DENE3** can be operated both on Zorro II (A2000) and Zorro III (A3000(T), A4000(T)) busses. The bus type is sensed automatically, in special cases operation in Zorro II mode can be forced by a jumper. Fast Zorro II mode on Zorro IV / Winner busboards is also supported.

As only USB card for the Amiga up to now the **DENE3** can operate with real Zorro III DMA. This means that data transfers are performed by the FPGA on the **DENE3**, and not the Amiga's CPU. This mode significantly reduces the load on the CPU in the multitasking system.

You may also use pure PIO operation as alternative. In this case all data transfers have to be handled by the CPU alone.

Due to several known bugs in the Amiga chipset (namely Buster) DMA operation is not possible or recommended in all system configurations. Please read the following information carefully, as malfunctioning DMA may cause data losses.

As a matter of fact DMA can **only** work with Buster Revision 9 and 11. Buster 7 does not allow DMA at all. Your system configuration,



especially already present busmasters, decide now if **DENE3** can be operated in DMA mode.

All Zorro III busmaster cards (A4091, Fastlane Z3) and the internal SCSI controller of A3000T/A4000T must be taken into account.

SCSI controllers located on CPU cards (e.g. CyberstormPPC) are not connected by Zorro III and need not to be taken into account. They can be used without any danger.

Buster 9: several busmasters can operate simultaneously, as long as all use a special workaround in hardware for Buster 9 (e.g. Fastlane Z3). Busmasters without workaround will drive the system instable (e.g. A4091, A3000T/A4000T SCSI).

Buster 11: only **ONE** busmaster may be active here in the system. Workarounds are not known at the time of this writing.

Examples:

A4000T with internal SCSI harddisk

No DMA possible on **DENE3**, PIO must be used.

A4000T, no SCSI devices connected to motherboard, Fastlane Z3

DMA can be used if Buster 9 is present; in case of Buster 11 PIO must be used.







5. Jumpers and LEDs

In normal operation no jumper settings are needed on **DENE3**. In some special cases some adjustment may be necessary.





The jumpers of **DENE3** are located on lower left side right above the Zorro connector (check fig. 1 on page 6). A brief description is located on the upper left edge of the **DENE3** PCB.

Please note: do not use any other jumper settings as described here! Jumpers may only be changed in power off state!



-  RESCUE mode: for firmware upgrades only. May **never** be set in normal operation. USB is only available as Zorro II in rescue mode. More information can be found in appendix A.
-  Zorro II mode: forces **DENE3** to operate in Zorro II mode. Should only be set in Zorro III systems in case of emergency, as Zorro III mode allows significantly higher rates.
-  ROM OFF: disables activation of FlashROM contents during booting. In case of problems when starting the computer with **DENE3** installed you can set this jumper to disable the FlashROM.
-  FSB: reserved. **DO NOT USE.**
-  TST: reserved. **DO NOT USE.**
-  SPARE: parking position for one spare jumper.

Four LEDs are located on the left side of **DENE3** to display the current operation mode:

-  "FPGA booted" - must always be on.
-  "Zorro II mode" - Zorro II mode is selected.
-  "Expansion power" - expansion port is activated.
-  "Rescue mode" - firmware upgrade mode is selected.

During the first installation of **DENE3** in your system the RESCUE jumper must be set. This allows accessing the (non erasable) installation software which has been stored in a specially protected area of the **DENE3** FlashROM.

After installation this jumper must be removed to unleash the full USB and FlashROM functionality of the **DENE3** in normal operation.



6. Installation of **DENE3**

Your **DENE3** card has been designed for the Zorro II/III bus (and completely compatible busboards).

6.1. Safety recommendations

Please follow these recommendations
for your own safety:

- ▶ Switch off your Amiga before installation.
- ▶ Remove the power supply AC cable.
- ▶ Disconnect all external devices.
- ▶ Avoid static charge.
- ▶ Follow your computer manufacturer's installation guide for expansion cards.
- ▶ Avoid any forces on the components of **DENE3** during installation! Do not apply pressure on any parts!

6.2. List of required material

- **DENE3** expansion card
- one holding plate with two USB adapter cables
- Philips style screw driver
- (perhaps) isolation material (thick paper)

Please check **before** starting with installation if the RESCUE jumper is still set (factory default, see section 5). This is needed for first time installation.

6.3. **DENE3** installation in the Amiga 2000

Open your Amiga 2000 housing by removing five screws in total: two on each side and one at the back of the housing. Afterwards, the upper part of the housing can easily be removed.

Zorro slots can be found on the left side of the mainboard. Insert your



DENE3 into a free Zorro slot. Components on the expansion card must be on the right side, facing your power supply unit!

Close your computer before reconnecting the AC power cable.

6.4. **DENE3** installation in the Amiga 3000 / 4000

The Amiga 3000 / 4000 housing is fixed by several screws on the back of the housing. After removing these screws the upper part of the housing can be taken off. Zorro slots are located on a daughterboard in the left part of the computer.

Insert your **DENE3** into a free Zorro slot. Components on the expansion card must be visible from top!

If your Zorro slot has already been used many times, then the **DENE3** card might not be fixed properly to the slot. In this case it is a good idea to electrically isolate the card by inserting some isolating stuff (not burnable!) between other installed cards. This will prevent shortcuts.

Close your computer before reconnecting the AC power cable.

6.5. **DENE3** installation in Amiga 3000T / 4000T

The Amiga 3000T / 4000T housing can be opened after removing several screws at the backside. Zorro slots can be found in the lower part of the computer on the mainboard.

Insert your **DENE3** into a free Zorro slot. Components on the expansion card must be visible from top!

Isolation issues: please see section 6.4 above.

Close your computer before reconnecting the AC power cable.

6.6. **DENE3** installation in Amiga 1200 Tower systems

Please consult your tower housing manual on instructions how to open the housing.

Usually the **DENE3** card has to be installed so that components on the expansion card are visible from top!

Close your computer before reconnecting the AC power cable.



6.7. Installing the hub ports

For external USB device one holding plate with two USB connectors is included in your **DENE3** package. This plate fits perfectly into the corresponding counterparts on the backside of your computer.

After complete remounting of your computer's housing you can continue with software installation for the **DENE3**. Please follow the steps described in the next section.

7. Setup and first steps

Do not connect any USB devices for the first test.

Switch on your Amiga now after closing its housing. Should you recognize any unusual behaviour of your Amiga, please switch it off immediatly.

7.1. The first start

Enter the boot menu by pressing both left and right mouse buttons and check the "Expansion Board Diagnostic" for the following entries:

```
Manufacturer: 3643    Product: 18    Status: Working  
Manufacturer: 3643    Product: 20    Status: Working
```

Boot now your system. The **DENE3** is switched for the first time installation into RESCUE mode and allows accessing the installation software located inside the FlashROM.

7.2. Software installation

Please install all the software found on the virtual drive "DenebInstall:" on your Amiga. It contains the USB stack Poseidon, the FlashROM utility Luciferin and some tools for firmware upgrade.

After finishing installation please switch off your Amiga and remove the RESCUE jumper.

Now you can use all features of your new **DENE3** !



7.3. Trouble shooting

Should problems occur during the first test, please carefully check if:

- the **DENEZ** is inserted into Zorro slot the right way?
- the **DENEZ** seats firmly inside the Zorro slot?
- the "FPGA booted" LED on **DENEZ** is lighting?
- the Zorro slot used is not weared out?
- any cables have been damaged or removed during installation?
- jumpers are located on wrong or reserved positions?
- the RESCUE jumper has been set for first time installation?

8. Setting up Poseidon

We assume at this point that you have installed the Poseidon USB stack after mounting the hardware. Please use the enclosed installer script for installing the software!

Its is good point in time to take some minutes and read the Poseidon manual, which has been installed onto your harddisk as AmigaGuide. You should make yourself familiar with the Poseidon GUI Trident.

Some configurations have now to be made inside Trident to suit your hardware configuration.

Amiga OS 3.x

Zorro II: please use the `denebz2usb.device` as driver

Zorro III: please read carefully the hints on DMA on page 6 and 7. If DMA is possible in your Amiga hardware setup, choose the `denebdmausb.device`; otherwise PIO mode must be used by choosing `denebpiusb.device`.

Amiga OS4 Classic:

At the time of this writing no DMA operation is possible with **DENEZ** under Amiga OS4 Classic. Please use in Zorro III mode the enclosed `denebpiusb.device`.



Appendix A. Firmware upgrades

Your **DENE3** is equipped with a modern FPGA which implements all Zorro bus logic and the Zorro III DMA engine. The functionality of this hardware component is defined by automatically loading a firmware image from a dedicated FlashROM on the **DENE3**.

With this design approach it is now possible for the first time to add improvements to the **DENE3** hardware while it is seated in your computer - no dismounting necessary, no chips to pull from sockets, no sending in is necessary anymore!!

Upgrading the firmware is only possible in a special operation mode of the **DENE3**. This mode is activated by setting the "RESCUE" jumper on the card while it is powered off.

Please note: due to mistakes made during firmware upgrades your **DENE3** may be rendered unusable! In this case E3B can reactivate your card only if you send it in. This service is charged.

Do not play with the firmware upgrade mode unless you need to!

Please read the documentation enclosed with the firmware upgrade tool **BEFORE** trying an upgrade. In case of doubt please ask our support before trying on your own!

Firmware upgrades will be published on our web site when available. A list of new features as well as possibly removed bus is also available with the download.

Upgrading the firmware is only recommended if current problems related to firmware in your setup can be solved.

Our firmware upgrade tool only allows using certified E3B firmware images. We strongly recommend not to use any other files from other sources!

Please remove the "RESCUE" jumper after the firmware upgrade procedure. The new firmware is available after a power cycle!

