



**BLIZZARD**

**2060 TURBO BOARD**

**68060 BESCHLEUNIGER KARTE UND  
FAST SCSI-II DMA CONTROLLER  
FÜR AMIGA 2000**

**ANWENDERHANDBUCH**

**68060 ACCELERATOR BOARD AND  
FAST SCSI-II DMA CONTROLLER  
FOR AMIGA 2000**

**USERS MANUAL**



# BLIZZARD

## 2060 TURBO BOARD

### 68060 ACCELERATORBOARD AND FAST SCSI-II DMA CONTROLLER FOR THE AMIGA 2000

## USER MANUAL

2nd Edition March 1996  
Copyright 1995/1996  
phase 5 digital products  
In der Au 27  
61440 Oberursel

Conceptual Design:	Gerald Carda, Wolf Dietrich
Hardware-Design:	Thomas Rudloff
Software:	Ralph Schmidt, Gerald Carda
Board-Layout:	Thomas Rudloff, Gerald Carda
Documentation:	Michael Sistig, Wolf Dietrich
Best boy on set	Thomas Knäbel
Best girl on set	Brita
Composition & Layout:	Michael Sistig

*All rights reserved. Specifications are subject to change without notice.*

*Workbench™, Intuition™, Amiga™, AmigaDOS™ are registered trade names of ESCOM AG. Product names used are registered designs and/or trademarks of the relevant manufacturer.*

*The text, illustrations, programs and hardware have been produced with the utmost care. All rights and changes to the technology and scope of supply are reserved. Phase 5 digital products accepts neither legal responsibility nor liability for any errors remaining in the data or the consequences thereof. This publication is protected by copyright. All rights are reserved. No part of this manual may be reproduced by photocopying, microfilm, text file or other process or be transferred into a language used for machines, in particular data processing equipment, without the express written authorisation of phase 5 digital products. Translation of this manual into other languages, especially Spanish or French, must also be authorised by phase 5 digital products.*

**PREFACE**

Many thanks for choosing our product. With the overwhelming performance of the latest and fastest processor of the 68k-family, the Motorola 68060, the BLIZZARD 2060 Turbo Board brings along a performance level for the AMIGA 2000 which was formerly unthinkable in this form and at its price. With more than 80 MIPS performance and the high performance of the integrated floating point processor unit (FPU), the AMIGA 2000 becomes a powerful workstation, which is more than suited for today's most demanding applications such as 3D-calculations and ray-tracing, image processing, animation or video processing.

Some of the most important features of the BLIZZARD 2060 Turbo Board:

- ▶ *High-End acceleration board for the AMIGA 2000 with 50 MH-68060 processor with FPU and MMU for highest and maximum performance*
- ▶ *Four 72-channel standard-SIMM-sockets for the memory expansion up to 128 Mbyte main memory (merged assembly is also possible)*
- ▶ *Automatic self-integrating (auto-configuring) memory with optional mirroring of the operating system (MAPROM-function, deselectable) for additional power increase*
- ▶ *An extremely fast memory layout grants highest data throughput in the fast RAM*
- ▶ *Asynchronous design for full Genlock-compatibility*
- ▶ *Can be reset to 68000-processor through the keyboard for full compatibility with all software (possible with AMIGA 2000 model „B“ only)*
- ▶ *Integrated Fast SCSI-II DMA controller with transmission rates of up to 7 Mbyte/sec. asynchronous and up to 10 Mbyte/sec. synchronous on the SCSI-bus*
- ▶ *Through DMA - transmission (Direct Memory Access) the processor on the BLIZZARD 2060 Turbo Board is not charged. Thus, the BLIZZARD 2060 Turbo Board is optimally suited for multimedia-applications*
- ▶ *Solderless and simple assembly in the processor expansion slot of the AMIGA 2000*
- ▶ *High-quality processing in latest SMD-technology*

At this point we kindly ask you to fill in the registration card which is attached to this product, and return it to us. At the one hand, we can inform you about possible future expansions for the BLIZZARD 2060 Turbo Board as well as other developments around the AMIGA 2000, at the other hand you shall help us with your opinion to further develop and bring on the market for the future those products for the Amiga, which you as user desire.

**CHAPTER 1  
THE BLIZZARD 2060 TURBO BOARD**

**SCOPE OF DELIVERY**

On receipt of the BLIZZARD 2060 Turbo Board please check that the delivery scope is complete. The package must contain:

- ▶ *One board (BLIZZARD 2060 Turbo Board)*
- ▶ *Two installation disks*
- ▶ *This manual*

If one of these parts should not be contained, please refer to your retailer.

**IMPORTANT! BEFORE BEGINNING WITH THE ASSEMBLY**

Before you begin with the assembly of the BLIZZARD 2060 Turbo Board, you should first consider the following items.

1. *To function correctly, the BLIZZARD 2060 Turbo Board needs special 68060 - specific software. This software has to be installed before the assembly of the BLIZZARD 2060 Turbo Board. See also chapter „Software installation“.*
2. *The AMIGA 2000 has been delivered as two different models by Commodore, namely the older models (A) and the later models (B). You can find out which model your AMIGA is from the imprint on the left bottom side of the main board. If you discover here a label with the imprint „COMMODORE AMIGA 2000“, a serial number and „MADE IN GERMANY (BSW)“, then your AMIGA is a model (A). With these models, the 68000 CPU has to be removed before you begin with the installation of the BLIZZARD 2060 Turbo Board. Please by all means read the Appendix B „Installation in the AMIGA 2000, model (A)“ before you begin with the assembly!*
3. *Find out with which Kickstart-ROM your AMIGA 2000 is furnished. To grant the full functionality of the BLIZZARD 2060, we urgently recommend the usage of Kickstart-ROM Version 3.1. Should you have a different Kickstart-version, please read the Appendix A „Working under Kickstart 1.3 or 2.04“ first.*
4. *If you want to expand your BLIZZARD 2060 Turbo Board with memory modules (SIMMs), please read the corresponding chapter first, because the assembly of the SIMMs has to be made before inserting of the BLIZZARD 2060 Turbo Board into the computer.*

**ASSEMBLY OF THE BLIZZARD 2060 TURBO BOARD**

Remove all cables (mains cable, monitor cable, mouse, serial and parallel cables), as well as, if applicable, all externally connected units from your AMIGA 2000. Now loosen the two screws on the lower left and right side of your AMIGA 2000 (illustration 1).

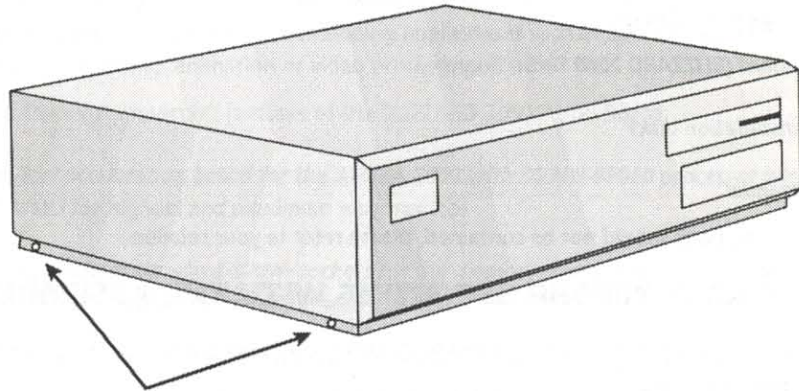

*Illustration 1. Screws on the lower left side of the Amiga 2000*

On the rear, remove the middle screw lastly. In doing so make sure that you remove the correct screw as shown in illustration 2.

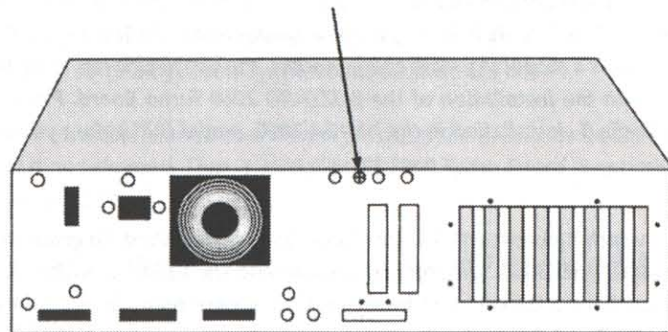

*Illustration 2. Center screw on the rear of the AMIGA 2000*

Now you can take off the cover of the AMIGA 2000 by pulling it cautiously forward and upwards. Should you notice resistor when taking off the housing lid, please use no force, but look below the lid, possibly a cable or alike has been caught on the cover.

After having opened the cover, you will recognize on the left beside the 68000 CPU the 86-channel processor expansion slot of the AMIGA 2000 (illustration 4). The board has to be fitted into this slot. Before fitting in the BLIZZARD 2060 Turbo Board, please first remove the slot cover plate belonging to the processor expansion slot at the rear of the AMIGA 2000. Now you can

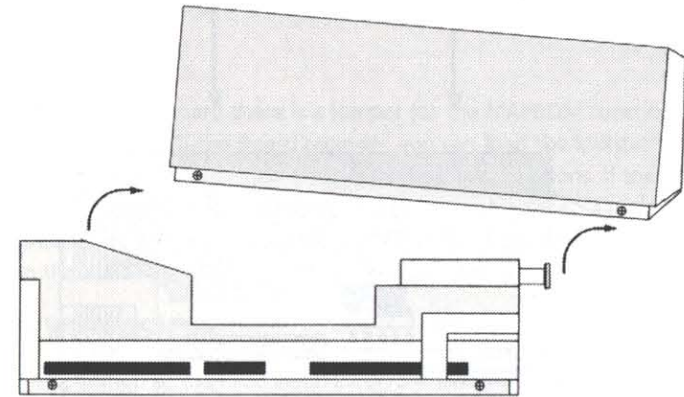

*Illustration 3. Cover removal – side view*

carefully enter the BLIZZARD 2060 Turbo Board as shown in illustration 5. Please take care that the BLIZZARD 2060 sits properly in the plastic guidance rail on the front of the AMIGA 2000, and that no cables or others are jammed below the board. Now fix the board by applying light pres-

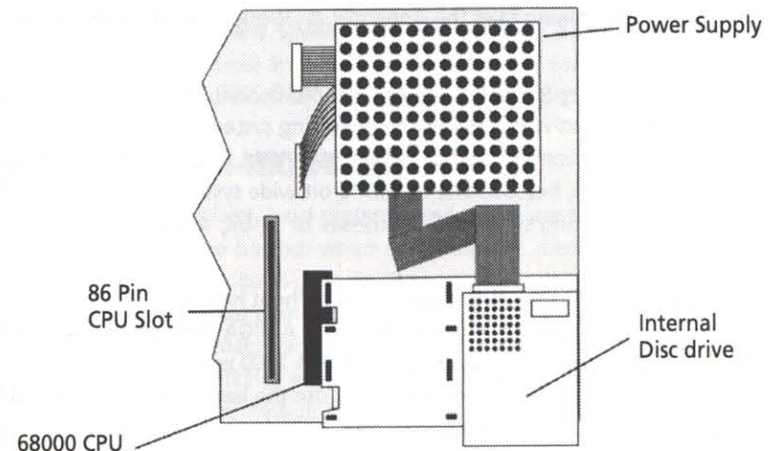

*Illustration 4. Right side view (looking down)*

sure from above as shown in illustration 5. If the board sits properly in the appropriate slot, you can now fix the screws of the earlier loosened slot cover on the rear of the AMIGA 2000. Now you can re-fasten the cover of the AMIGA 2000 and re-connect all removed cables and peripheral units. Herewith, the assembly of your BLIZZARD 2060 Turbo Board is finished.

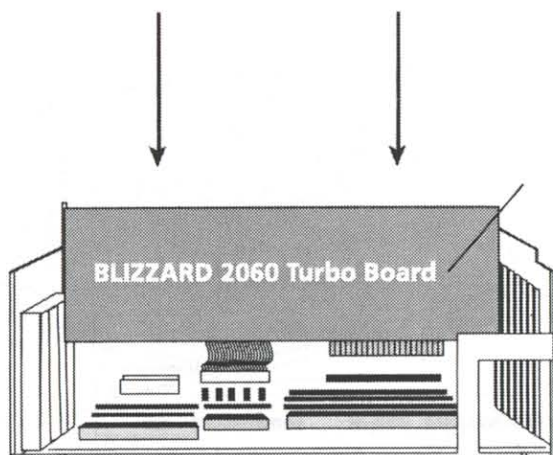

Illustration 5. BLIZZARD 2060 installation (side view)

## OPERATION OF THE BLIZZARD 2060 TURBO BOARD

If you dispose of the Kickstart Version 3.1 in your AMIGA 2000, then the BLIZZARD 2060 Turbo Board is immediately ready to use, and puts its performance at your disposal directly after having been switched on. If your computer is furnished with a different Kickstart Version (e.g. Version 1.3 or 2.04), then please read the Appendix A „Working under Kickstart Version 1.3 or 2.04“ first.

If you have installed memory (Fast RAM) on the BLIZZARD 2060, you can define through a jumper if the MAPROM function which copies the operating system into the faster Fast-RAM shall be activated or not. It is recommended to let the MAPROM function switched on at all times (always activated ex works), because due to the 16 bit-wide system architecture of the AMIGA 2000 it expands the operating system ROM-accesses to 32 bit, and so accelerates them considerably.

The BLIZZARD 2060 Turbo Board can be deactivated without having to be de-assembled, if compatibility problems occur with certain programs. (As in AMIGA 2000 Model „A“ the 68000 CPU has to be removed, the reset is only working in AMIGA 2000 model „B“!). To de-activate, hold down the key „0“ during booting. However do not use the key „0“ on the numeral block. The BLIZZARD 2060 Turbo Board is then completely deactivated, which will readjust the AMIGA 2000 to the standard configuration. however please consider that not only the processor of the board is deactivated, but also all expansions, which are operated on the BLIZZARD 2060 Turbo Board.

So after the deactivation, neither the memory nor the integrated SCSI-II controller are available. The BLIZZARD 2060 can be re-activated, by keeping the key combination which is required for resetting (CTR-AMIGA-AMIGA) down for more than 10 seconds.

## JUMPER

For a complete description of the jumpers which are available on the BLIZZARD 2060 Turbo Board please turn to Appendix C „Jumper on the BLIZZARD 2060 Turbo Board“.

## MAPROM

On the BLIZZARD 2060 Turbo Board there is a jumper for the MAPROM function. If memory is loaded on the BLIZZARD 2060 Turbo Board memory, you can load the kickstart into the faster RAM, in order to accelerate the execution of operating system functions. If the MAPROM jumper is plugged in, the kickstart is automatically recopied. If the jumper is pulled out, the kickstart is executed from the ROM. The (activated) MAPROM function occupies 512 Kbyte of the RAM installed on the BLIZZARD 2060 .

## MEMORY EXPANSION

Adjustment and recognition of the RAM installed on the BLIZZARD 2060 is completely automatic. For the memory assembly you need 32-bit-SIMMS, available general under the trade mark PS2-module. The BLIZZARD 2060 accepts SIMMS or thememory sizes 4MB, 8MB, 16MB, 32MB, and also allows merged assembly of these SIMS. The organization of the SIMMS may be 32 bit as well as 36 bit. The 36-bit SIMMS are used in IBM-compatible

PCs, which use the additional 4 bit as parity bit. With the BLIZZARD 2060, these additional bits are ignored. For the operation in a BLIZZARD 2060 SIMMS with a speed of 70 ns or faster are required.

Please consider that some SIMM-modules of different suppliers are available which do not maintain the imprinted speed. Especially SIMM-modules which bear e.g. the imprint LaserPrinter-Memory (or similar phantasy labels) are unservicable as memory for computer systems. phase 5 digital products principally recommends not to use such SIMM-modules.

## ASSEMBLY OF SIMM-MODULES

Put the BLIZZARD 2060 on a plane, hard underground. Be aware that sensitive surfaces could be scratched by the pins onthe bottom when mounting the memory module, therefore we recommend to use e.g. a magazine as support. Now align the BLIZZARD 2060 Turbo Board so that the external SCSI-II connector points towards the right. The memory SIMMS have a recess opening on one side of the contact strip, so that they can not be mounted upside down. This recess opening must be at the left side when mounting. Insert the Simm at an angle of aprox 40 ° flush into the socket, thus the module can be inserted without problems. Then softly press down both upper corners the SIMM down with your thumbs, until it audibly locks into place. Take care that the metal hooks left and right besides the fixation holes both lock in over the

board of the SIMMS. Take care for all handling steps, that the SIMs must not be subject to strong mechanical stress.

**Note:** Generally it does not matter in which sequence resp. in which of the four SIMM-sockets you insert your SIMM(s).

**SOFTWARE INSTALLATION**

The included software contains the necessary libraries for the operation of the 68060 CPU, the command CPU060, an equivalent to the CPU command of the operating system, as well as some tools for the operation of the 68060 CPU.

Through the installation, the 68040.library, if existing, is renamed and the libraries 68040.library and 68060.library are copied into the directory LIBS: furthermore, the CPU060 command is copied to C: and a drawer with the designation SOFT060 is generated in the system partition which contains the tools for the operation of the 68060 CPU.

**ATTENTION!**

 *The installation of the software must in any case take place before the assembly of the BLIZZARD 2060 Turbo Board !*

Should the operation of a 68000, 68020, 68030 or 68040 Cpu be necessary, then you need make no modifications of the installed software. The present version of the 68040.library which is delivered together with the BLIZZARD 2060 automatically recognizes the inserted processor and loads the required library.

The software installation is made through an installation script. Insert the delivered disk and open it through double mouseclick. Before the final installation, you should doubleclick on the „ReadMe“-file to open it. In this text, the actual information on the software is contained. The software is then installed through doubleclick on the INSTALL icon. The program in the SOFT060 directory have their own documentation on the disk, the command CPU060 has, in addition to the arguments of the CPU command, the following arguments:

**(NO)SUPERSCALAR** (de)activates the superscalar mode of the processor

**(NO)BRANCHCACHE** (de)activates the branchcache

**CHAPTER 2  
THE FAST SCSI-II DMA CONTROLLER**

**CONNECTION OF ALREADY RDB-FORMATTED SCSI-DRIVES**

If you connect a hard disk (or resp. another SCSI-unit) to the BLIZZARD 2060 Turbo Board, which was formerly operated on a SCSI-controller in the AMIGA and formatted with the RDB (Rigid Disk Block) according to AMIGA-standard, this unit is immediately ready to use.

After the computer has been started, the partitions existing on this disk must be automatically recognized and, resp. even booted. If this is not so, contact your retailer in any case, before undertaking further measures.

**ATTENTION!**

 *If you want to connect hard disks which you already operate at a different controller, and on which data are memorized, we urgently recommend to make a safety backup of the hard disk **before** removal out of the old system. Each new connection of an already operated hard disk bears the risk – if ever so small – of a data loss through error at installation or putting into operation. If the backup on floppy disk seems too slow, ask your retailer if he could take over the backup and re-installation for you (e.g. on a streamer), or if you could borrow a streamer, possibly against a low fee. We expressively state that we take over no warranty whatsoever for data losses on hard disks or SCSI-units which have been previously used before being connected to the BLIZZARD 2060 Turbo Board.*

**CONNECTION OF EXTERNAL SCSI-DEVICES**

To the 50-channel HigDensity Fast SCSI-II connector of the BLIZZARD 2060 Turbo Board you can connect external SCSI-units with a commercial brand SCSI-II cable. Most external SCSI-units are furnished with 50-channel Centronics-connections, so that for those a cable with 50-channel SCSI-II-plug on one side and standard SCSI Centronics 50-pole plug on the other side can be used. Further SCSI-units can then be connected via the first unit, while between the units generally cables with 50-channel connection on both sides are used. In any case, you have to take care of correct bus-termination (see SCSI-bus termination), as otherwise problems with the data transmission could occur.

During operation, you have to take care that the power supplies of the external units should always be activated before switching on the computer, and deactivated only after the computer has been switched off.

**THE SCSI-BUS**

**ATTENTION!**

For the connection of external SCSI-units only top-quality screened cables are admitted, which comply with the valid standards (CE, FCC, or similar). For purchasing such cables, which offer the corresponding attenuation properties, please turn to your retailer. Please also be aware that external SCSI-units have to fulfill the valid standard norms!

**SCSI-BUS TERMINATION**

To grant a faultless, unimpaired function for the SCSI-bus system, the SCSI-bus has to be terminated electrically correct. You can think of the SCSI-bus as a single cable, which has to have a terminal resistor at each end. The single units are then directly connected to this cable. It follows that the termination resistors may only be installed on the first and last unit. In this regard, the controller counts as one unit. (see illustration 6). The SCSI-module on the BLIZZARD 2060 is furnished with an active termination, which automatically switches on and off, depending on if external SCSI-units are connected or not. (please also see the Appendix C „Jumper on the BLIZZARD 2060 Turbo Board“ and the chapter „SCSI termination jumper“.)

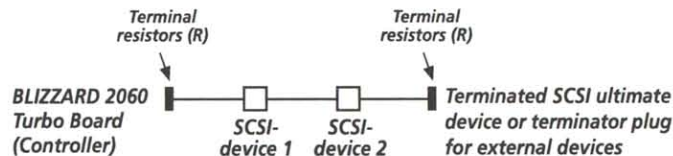

Illustration 6. Example of a SCSI-chain with properly set terminal resistors

On the usual SCSI-units such as hard disks, alternation disk drives, or streamers, termination resistors are also installed. The termination resistors generally are positioned close to the SCSI-plug. If the resistors are socketed, you can simply remove them if required. Should the resistors not be socketed, (which is sometimes the case for newer SCSI-units with SMD-soldered resistors or active termination on the unit-side), there generally exists a jumper or switch on the SCSI-unit, with which it can be switched off. For the localization of such jumpers or switches, or if you have problems to identify the termination resistors, please refer to the documentation of the corresponding SCSI-unit. With external units (e.g. scanners) or external drives it could be, depending on the supplier or delivery scope, that instead of resistors installed on or in the unit, an external SCSI-termination plug is positioned on one of two external SCSI-connections.

**ATTENTION!**

The correct termination is inevitable for a faultless operation of the controller and other connected units. An erroneous termination can lead to data transmission errors, non-recognition of SCSI-units, or in the worst case, to data losses on the memory media. Please take greatest care that the termination is made correctly.

**NOTE!**

If you remove terminal resistors, please do not forget to note down the fitting position, in case you have to re-insert the resistances. In most cases there is a marking on the board, which has to be in accordance with the point on the resistor.

Basically we can distinguish the following four connection combinations for the termination (what is said in the following for „hard disk“ is of course also valid for other SCSI-units).

**Operation of the SCSI-controller with an internal hard disk**

Attention has to be paid that the termination resistors are installed on the hard disk. For the connection of the hard disk with the SCSI-controller use the respective plugs at the end of the internal SCSI-cable.

Position of the SCSI Termination Jumper in this case: **ON** or better **AUTO**

**Operation of the SCSI-controller and several internal drives**

The terminating resistors must be installed on the disk drive at the other end of the internal SCSI cable. The SCSI-controller must be connected to the first connector on the SCSI cable and a hard disk must be connected to the last connector. Additional disk drives can be connected to any free connectors on the internal SCSI cable.

Position of the SCSI Termination Jumper in this case: **ON** or better **AUTO**

**Operation of the SCSI-controller with external units without internal hard disks**

If you connect units via the external SCSI-connection of the SCSI-controller, without having internally connected a SCSI-unit, termination resistors may and must only be existent for the last unit, and the termination jumper on the external SCSI-plug has to set from AUTO to ON (see chapter „SCSI Termination Jumper“). As external units are mostly furnished with two SCSI-connections, to loop through the SCSI-bus, (i.e. to connect together several external SCSI-units in series), then the termination resistors should not be assembled on the SCSI-units (i.e. the hard disks, alternation disks, streamers, etc.) themselves. It is better to use a SCSI-termination plug, which is plugged in the free SCSI-connector on the last unit, this makes it possible that external units are looped in serial, at which only the termination plug again has to be plugged into the last free connection of the last unit. SCSI-termination plugs are available from retailers.

**Operation of the SCSI-controller with external units and internal hard disks**

External units have to be terminated as described in the previous paragraph. Internally, only one

SCSI hard disk should and may be terminated, and this must be connected to the last plug of the internal SCSI-cable. The other end of the internal SCSI-cable is plugged into the SCSI-controller. Position of the SCSI termination jumper in this case: **ON** or better **AUTO**

### ADJUSTMENT OF THE SCSI-ID OF THE CONNECTED UNITS

For the distinction of different units, which are connected to the SCSI-bus, SCSI-units have a so-called SCSI-ID which can represent a value from 0-7. The integrated SCSI controller on the BLIZZARD 2060 Turbo Board itself has the ID 7. This means that to one BLIZZARD 2060 Turbo Board up to 7 SCSI-units with the IDs 0-6 can be connected. If more SCSI-units shall be connected to the BLIZZARD 2060 Turbo Board, then the SCSI-IDs of these units have to be adjusted so that no unit has the same ID. The SCSI-ID for external SCSI-units is generally adjustable with a small switch by the user. Herefore please consult the documentation of the correspondign SCSI-unit.

#### ATTENTION!

 If two units are connected to the BLIZZARD 2060 Turbo Board with the same SCSI-ID, this could damage one of the SCSI-units. In any case, only one unit is recognized by the BLIZZARD SCSI-software. Vice versa, if after the connection of e.g. a new hard disk this unit is not recognized by the BLIZZARD-SCSI-software, this may be a hint that possibly a SCSI-ID is adjusted at this board, which is already occupied by another unit. The same is of course also valid, if a new disk appears, but suddenly a earlier connected unit can no longer be called. To avoid operation of two SCSI-units with the same ID in any case, you should check before the connection of a new SCSI-unit with the BLIZZARD SCSI-software (e.g. the Program Unit Control) which SCSI-IDs are already assigned/occupied.

#### NOTE!

 The sequence in which the SCSI-IDs are assigned can principlaly befreely chosen, i.e. neither must the SCSI-IDs be assigned continuously, nor does the selectable SCSI-ID depend on the position of the unit in e.g. a series of connected disks. Nevertheless it is recommended to assign the ID 0 to the first connected unit, and to assign later connected units with the following IDs in ascending sequence, as this can considerably shorten the system start-time.

#### ATTENTION

 With some hard disks it could happen that they do not function properly on the SCSI-ID 0. In this special case, please change the SCSI-ID on to any other ID.

### SCSI-CONFIGURATION

The SCSI-controller on the BLIZZARD 2060 is provided with different possibilities for the SCSI-configuration. These are adjusted via the SCSI-device-config-jumper. The SCSI-device-config-jumper are above the plug for the internal SCSI-cable (see also the Appendix C „Jumper on the BLIZZARD 2060 Turbo Board“).

### SCSI CONFIG JUMPER

The jumpers are continuously numbered from 0 to 7, while jumper 0 is at the bottom and jumper 7 is at the top. (see also the Appendix C „Jumper on the BLIZZARD 2060 Turbo Board“).

The individual jumpers have the following functions:

*Jumper 7: reserved (open)*

*Jumper 6: reserved (open)*

*Jumper 6: reserved (open)*

*Jumper 4: Synchron Auto-Enable (closed))*

If this jumper is connected, the SCSI-controller evaluates at connected SCSI-units (especially hard disks and removable disks) information eventually entered in the RDB (Rigid Disk Block), if the hard disk is to be operated in the synchronous mode, and then activates the synchronous transmission mode automatically. If this jumper is not connected, then an eventually existing synchronous entry is ignored, and the hard disk is operated in the standard-asynchronous-mode.

*Jumper 3: Slow cable mode (open)*

This jumper should only be connected if during the usage of extremely long cables, especially at the connection of external SCSI-units, transmission problems occur (normally only for cable lengths > 5m).

*Jumper 2: Slow Inquiry Mode (open)*

This jumper should be set when hard disk (which can occur especially with older models), after the computer has been switched on are not directly recognized, but only after another reset. This is due to too long a warm-up time of the hard disk. With the slow inquiry jumpers, the time is prolonged, for which the SCSI-controller waits for the reaction of the hard disk after the first request.

*Jumper 1: reserved (open)*

*Jumper 0: Debug mode (open)*

Only for test purposes by authorized service personnel.



## SCSI TERMINATION JUMPER

### 1-2: AUTO (Auto Detect)

The termination resistors are activated, but are switched off through plugging in another external cable. This adjustment must be set, if you have connected one or more SCSI-units, notwithstanding if external units are connected or not.

### 2-3: OFF (Termination OFF)

The termination resistors are switched off not depending on the connection of an external cable. This adjustment is not to be used in standard operation.

### Open: ON (Termination ON)

The termination resistors are activated not depending on the connection of an external cable. For explicitly switching off the termination through an experienced user.

### Termination power (TP) connected

If this jumper is connected, the SCSI-controller activates the supply voltage for the termination resistors on the SCSI-bus.

## THE SCSI SOFTWARE

The disk included in the delivery contains comprehensive software for the installation of the hard disk, as well as for individual adjustments. Furthermore, a CD-ROM file system and the changing software DynamiCache are included in the delivery scope, which can be used for increasing the performance in many applications.

The documentation for the delivered software is contained on the disk in form of a HotHelp-File. This can be called during the usage (by stroking ALT and HELP), and explains the functions of the software through a comprehensible user guidance menu.

The SCSI software is installed by opening the disk-icon on the SCSI-tools disk through doubleclicking. On this disk, you shall find an icon with the label Install. Before using the SCSI-tools and the HotHelpfiles, you have to start this program by doubleclicking on the icon once. The installation is then carried out by an installer script.

## ERROR TRACKING

### Error: The computer can't be started

Check if the mains cable has stable contact. If this is so, kindly contact your retailer.

### Error: Autoconfig-error

If after the starting of the computer resp. after a reset a red screen appears with the title „Expansion Board Diagnostics“, then please refer to your retailer.

### Error: No conneted SCSI-unit is recognized

Check if possibly the BLIZZARD 2060 Fast SCSI-controller itself is not configured (by means of the program „Show Config“ in the tools directory of the workbench). If this is the case, please refer

to your retailer. Under correct configuration of the BLIZZARD 2060 Fast SCSI-controller, please also check all the items of the next error description.

### Error: A new SCSI-unit is not recognized

Check if the unit is conected to the internal power supply. for external units: Check if the mains cable of the external unit is connected correctly, and if the unit is switched on.

Check the SCSI-ID of the connected units.

Check the connection of the SCSI-cable on the BLIZZARD 2060 Fast SCSI-controller and on the SCSI-unit.

For external units check the correct position of the external SCSIcables.

Check the correct SCSI-bus-termination.

If necessary exchange the cable or connect (for internal units) the SCSI-unit to another plug of the cable, to find out eventual errors of the cable.

### Error: The partitions of a disk which was formatted earlier are not recognized

First you should check with the program Unit Control which is delivered together with the BLIZZARD 2060 if the respective hard disk is physically recognized. If this is not the case, please carry out the instructions of the previous error description. If the disk is recognized, check if the formerly used controller was RDB-compatible, and also oblige the step-by-step instruction for the configuration of a hard disk. If with the instructions given there you still can not configure the disk, please refer to your retailer before you undertake further measures.

### Error: During operation of a hard disk, transmission errors occur

Check the correct SCSI-bus-termination resp. termination of the individual conneted units.

Check the SCSI-IDs of the connected units.

Check the correct termination of the SCSI-cable. If necessary exchange the cable, to find out possible cable malfunctions.

Another cause for transmission errors could be if a SCSI-unit, especially during operation with long cables, is operated in the synchron-mode with high transmission rates. In this test try to decrease the transmission rate by means of UnitControl.

### Problem: A SCSI-unit works slower than expected.

Check the correct adjustments of the synchronous transmission and the mask- and maxtransfer-values of the concerned partitions. You can use the program checkMask for this purpose.

Check for partitions operated under AMIGA -DOS if those are operated with the FastFileSystem (FFS). The adjustment FastFileSystem International Mode (FFS Int). can cause performance losses, also the AMIGA-DOS formatting with directory cache often leads to a considerable decrease of the transmission rate.

If necessary check if the hard disk is fully utilized, and the files are distributed over many tracks. in such a case it can be sensible to optimize the hard disk, special programs for this purpose, so-called disk-optimizer, are available. Please pay attention to the operating instructions when using such programs.

**General remarks to the error tracking**

Another reason for errors which often causes unexplicable malfunctions of the system, is the usage of non-system conform software, which for example does not work correctly with the Workbench 3.1 of the AMIGA 2000. This could also be seemingly unimportant, little utility programs, which are e.g. called in the startup-sequence. If you have an individually configured system, it is important, that you eliminate this error source also, by executing a test with a standard configuration.

Should you have problems, which do not correspond to the above listed, or which can not be eliminated with the proposed solutions, please refer to your retailer. Before calling him, make a very precise error description, which states your system configuration as well as resp. system error numbers in case of system breakdowns, and keep pen and paper ready.

**SCSI-BUS PIN ASSIGNMENT**

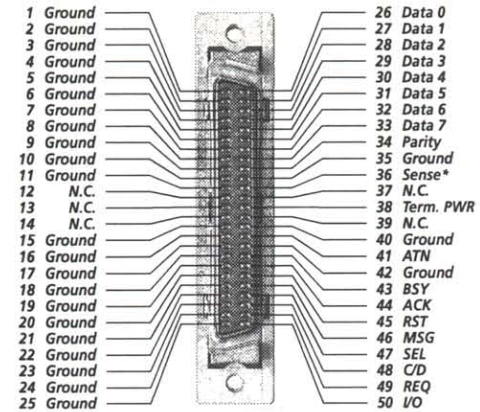

External SCSI-socket at the BLIZZARD 2060 Turbo Board (SCSI-II 50-pole)

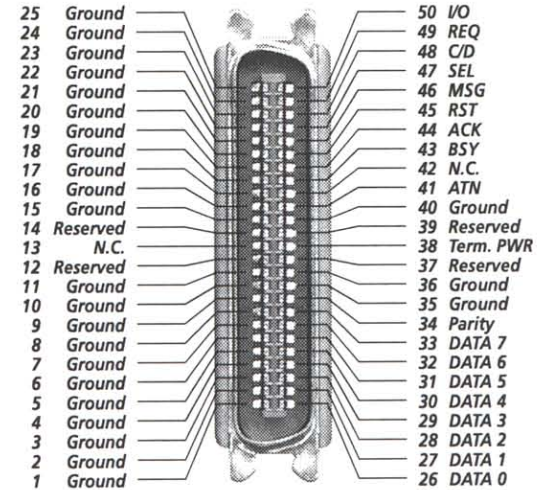

Connection cable assignment (Centronics 50-pole)

**CHAPTER 3  
GUARANTEE, TECHNICAL ADVISING AND SERVICE**

**GUARANTEE TERMS**

On this BLIZZARD 2060 Turbo Board, phase 5 digital products gives a guarantee of 12 months for components and processing, starting with the date of first sales. (Date of the retailer's bill issued to the registered final customer). Within this guarantee period, we eliminate all defectives, at our free choice either by exchange or repair, which are due to material or production faults. Through the execution of guarantee services, the guarantee period is by no means affected. Considering the included software (DynamicaCache/Cdrive), this guarantee refers only to the data carrier (disk).

Excluded are guarantee services for damages or malfunctions, which have been caused by outside interference or improper usage, especially also unauthorized repair. Modifications of the hardware, of what kind so ever, make the guarantee claim null and void.

also excluded are guarantee services for malfunctions or function disturbances on the BLIZZARD 2060 Turbo Board, on other units connected on/to the AMIGA, or of the AMIGA itself, which occur after the assembly of the BLIZZARD 2060 Turbo Board or later modifications of the system (as e.g. the insertion of new expansions), as far as it can not be doubtlessly proven that a technical defect of the BLIZZARD 2060 Turbo Board is the cause of the malfunction or function disturbance. Modifications of the hardware and/or software of the AMIGA are expressly included, which are carried out through the company AMIGA Technologies in form of repairs, upgrades, or system-updates.

phase 5 digital products takes over no warranty what so ever that this product is suited for a certain application. Furthermore, we take over no liability for defects or damages on other units than the BLIZZARD 2060 Turbo Board, as well as expressly not for the loss of data, which are or seem to be in direct or indirect connection with the usage of the BLIZZARD 2060 Turbo Board or the included software (DynamicaCache/Cdrive), even if we have been informed about the possibility of such a connection in advance. For also delivered hard disks or other SCSI-units, exclusively the guarantee conditions of the respective producer are applicable.

In any case please return your registration card stating the date of purchase and serial number of the BLIZZARD 2060 Turbo Board, so that in case of problems or guarantee handling this can be processed without further demands or delays.

**TECHNICAL ADVISING AND SERVICE**

Should you need technical information e.g. for the assembly, expansion or compatibility of your system configuration, please refer to your retailer, who will advise you with corresponding competence and offer you the suitable expansion products. The experienced AMIGA- resp. phase 5 digital products retailers have the necessary knowledge as well as additional service informations, which will contribute to fast problem solution in case of simple technical pro-

blems or compatibility matters. Also for the assessment of possible guarantee cases (please also refer to the chapter „Handling of guarantee cases, returns“) your retailer can assist you. Furthermore, starting with the end of February, you will receive comprehensive support informations through our World Wide Web-server in the Internet. You will reach our home page under:

 <http://www.phase5.de>

Here you can request all sorts of technical information to actual and future products, which are important for general information or technical support. These information are permanently actualized, and contain e.g. hints to tested and suitable hardware expansions or well-known error sources and compatibility restrictions as well as tips and infos for solution of occurring problems. Of course actual software updates can be downloaded as well.

Actual updates of software drivers for our products, as far as available, can also be obtained through our support mailbox. You will reach our mailbox under :

 **phase 5 digital products Support-BBS: (061 71) 58 37 90**

Should your retailer at times be not able to help you, or you have no access to our electronic support media, please refer in writing, by fax or by phone to our support department (see next chapter „Support, guarantee handling, returns“).

**SUPPORT, GUARANTEE HANDLING, RETURNS**

For the handling of guarantee cases, in Germany please contact.

*phase 5 digital products*

*In der Au 27*

*D-61440 Oberursel*

*Germany*

*Support-Department: +49 (0)6171/583788*

*Telefax: +49 (0)6171/583788*

In all other countries kindly contact directly our distributors or your retailer for the handling of guarantees. Please be aware that returns will only be accepted after advance agreement and authorization through our support. This assigns a RMA-number, which has to be marked good legibly on the return package. Please be aware that returns without RMA-number cannot be handled. Also, unfree returns are not accepted.

As far as in case of authorized return, no defect is to be noticed, a handling fee of DM 50,— (as of February 1996) is charged, if a defect is noticed, which is not subject to the guarantee hand-

ling, then the handling fee and in case of repair also a repair fee which depends on the defect is charged.

For transport damages, which are due to unsuitable packaging of returns of units, no liability can be taken over. For any return of a BLIZZARD 2060 Turbo Board always use the original packaging, and additionally a stable outer wrap (e.g. postal package) and resp. filling material (e.g. biodegradable filling materials).

## **APPENDIX A WORKING UNDER KICKSTART 1.3 OR 2.04**

As mentioned at the beginning of this manual, we urgently recommend the usage of Kickstart Version 3.1 to enjoy the full performance range of the BLIZZARD 2060 Turbo Board. Should you have installed Kickstart Version 1.3 or 2.04 in your AMIGA, please consider the following items:

### **KICKSTART VERSION 1.3**

Because Kickstart 1.3 does not recognize the 68060 properly ( it will be identified and initialized as a 68030 without FPU) and therefore only a part of the functionality is available. This means, that the buildin MMU and FPU can not be used.

Applications using this features (e.g. Raytracer and similar software) will not function properly or even not at all, in worst case they will crash the system. Another problem is caused by the build in Fast SCSI-II Controller of the BLIZZARD 2060. This DMA-device depends on cache support-functions of the operating system, which are not available under Kickstart 1.3. Therefore the SCSI-II controller is deactivated on boot-time to enshure the integrity of your data. We encourage the usage of version 2.4 or better 3.1 to get the full the capabilities out of your BLIZZARD 2060 Turbo Board.

### **KICKSTART VERSION 2.04**

Allthough under Kickstart 2.04 the BLIZZARD 2060 is function properly, some of the latest versions of third party software are using features of the version 3.1. We therefore encourage the usage of version 3.1 to enshure full compatibility with this software.

**Note:** Older versions of the Kickstart (below 1.3) will not work with the BLIZZARD 2060 Turbo Board at all.

**APPENDIX B  
INSTALLATION IN THE AMIGA 2000, MODEL (A)**

If your AMIGA 2000 is a Model „A“, which is one of the first models of this computer, you have to remove the socketed 68000 CPU from the main board of the AMIGA 2000 due to a board layout error before you assemble the BLIZZARD 2060. But before you remove the 68000, make sure that you have already installed the included software of the BLIZZARD 2060. For opening the housing, please read the chapter „Assembly of the BLIZZARD 2060 Turbo Board“ as far as the position where the BLIZZARD 2060 itself is assembled.

In order to reach the 68000 COU, you have to loosen four screws at the rear of the AMIGA 2000 which fix the power supply at the rear wall (illustration 7).

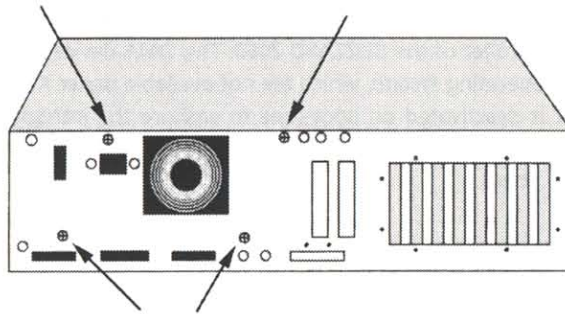

*Illustration 7. Power supply screws on the rear of the AMIGA 2000*

At the front, two screws have to be removed (illustration 8). Now you can lift the unit power supply/disk drive carrier carefully up and out. Should you have problems with internally connected plugs, flat ribbon cables, etc. when taking it out, loosen them carefully, and memorize or note down their position and orientation for the later re-assembly.

Put down the unit power supply/disk drive carrier best on the right side of your AMIGA 2000. On the right of the 86-channel processor expansion slot, the 68000 CPU to be removed is positioned (illustration 9).

Now you come to the point where you have to apply special caution, as the processor is generally stiffly fixed in its socket. However no force is required, but rather feeling and the right technique to loosen the processor.

Take a slot-screwdriver and insert it from below into the slot between processor and socket. Should the slot be too narrow, move the screwdriver to and from applying slight pressure or distort it slightly (illustration 10). If the screw driver is positioned between processor and socket, softly lift the processor a little through slight turning motions of the screwdriver, but really just a little bit. Repeat the just explained procedure on the other side of the processor, and you can now by means of continuously changing the sides by and by lift the processor completely off the socket. You will notice, that at each repetition, you can push the screwdriver a little further

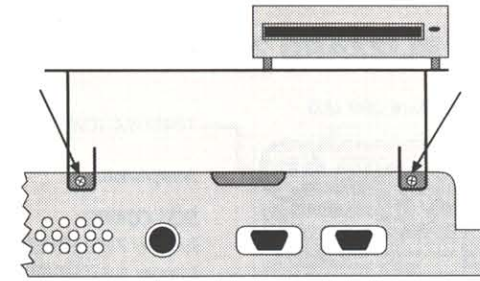

*Illustration 8. Disk drive carrier screws on the front of the AMIGA 2000*

under the processor. This longer level distance can be used to loosen the processor on its entire length with little effort and without jamming off its socket.

After you have removed the processor from the socket, you can re-assemble the unit power supply/disk drive carrier. Make sure that you re-connect any connectors, flat ribbon cables or other which you might have loosened properly.

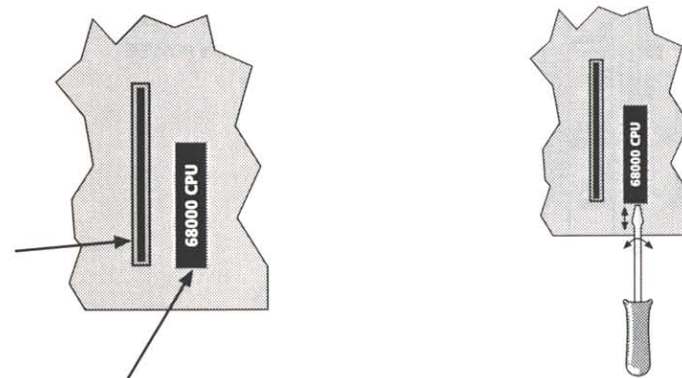

*Illustration 9 and 10. Position and removing of the 68000 CPU in the AMIGA 2000 model (A)*

Next you have to close the jumper „**ECLOCK**“ and „**CCLOCK**“ on the BLIZZARD 2060 (ex works in open position). Hereto see also APPENDIX C „Jumper on the BLIZZARD 2060 Turbo Board“. Now you can continue the assembly of the BLIZZARD 2060 as described in chapter „Assembly of the BLIZZARD 2060 Turbo Board.“

## APPENDIX C JUMPER ON THE BLIZZARD 2060 TURBO BOARD

